

HAZET – Wrenches

- ✓ Double Open-End Wrenches
- ✓ Double Box-End Wrenches
- ✓ Combination Wrenches
- ✓ Ratcheting Combination Wrenches
- ✓ Socket Wrenches and many more...



- ✓ Very slim and extremely sturdy
- ✓ Optimally suited for the professional use



Manufacturing Steps of a Wrench

- ✓ Designed, forged and finished completely in Germany
- ✓ Manufactured from selected German steels



HAZET tools have an elaborate surface

- ✓ **Mat chrome-plated** – the safer chrome plating, as it adheres optimally to the steel
- ✓ **Mat chrome-plated** – good grip and very comfortable in your hands
- ✓ **Mat chrome-plated** – non-slipping even with oily hands
- ✓ **Mat chrome-plated** – non-glaring when working
- ✓ **Mat chrome-plated** – looks unobtrusive and noble
- ✓ **Mat chrome-plated** – provides security to the user

Adjustable Wrench



- Head set at 15°
- With scale
- Chrome-Vanadium
- Surface phosphatized
- Mirror polished
- DIN 3117 form A, ISO 6787

HAZET No.	l mm	sb mm	EAN-No. 4000896+
279- 4	109	13	018086
279- 6	158	18	018093
279- 8	205	23	018109
279-10	255	28	018048
279-12	308	34	018055
279-15	382	43	018062
279-18	458	53	018079



- Head set at 22.5°
- With scale
- Chrome-Vanadium
- Surface chrome-plated
- Mirror polished
- DIN 3117 form B, ISO 6787

HAZET No.	l mm	sb mm	EAN-No. 4000896+
279 V- 4	109	13	018161
279 V- 6	158	18	018178
279 V- 8	205	23	018185
279 V-10	255	28	018147
279 V-12	308	34	018154

Hex Nut-Driver



- Ergonomically shaped trinamic handle
- Surface chrome-plated
- DIN 3125

HAZET No.	l ₁ mm	l ₂ mm	EAN-No. 4000896+
425-5	125	236	019083
425-5,5	125	236	019090
425-6	125	236	019106
425-7	125	236	019113

Hex Nut-Driver

HAZET No.	l ₁ mm	l ₂ mm	EAN-No. 4000896+
425-8	125	235	019120
425-9	125	235	019137

Blade with hex-bolster

425-10	125	243	019014
425-13	125	243	019045

Flexible Hex Nut-Driver

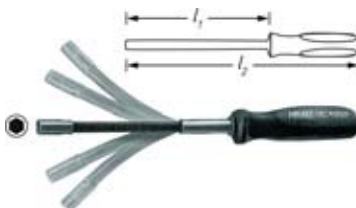

- e.g. for the hose clamps on radiator hoses
- Flexible blade
- Ergonomically shaped handle

HAZET No.	l ₁ mm	l ₂ mm	EAN-No. 4000896+
426- 5	190	300	019243
426- 6	190	300	019250
426- 7	190	300	019267
426- 8	190	300	019274
426-10	190	300	019236

Hex Nut-Driver

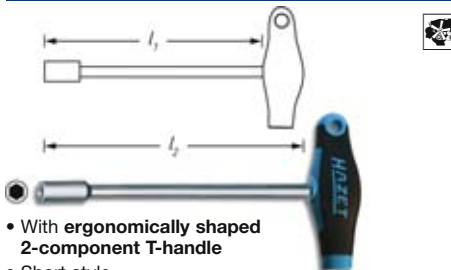

- With ergonomically shaped 2-component T-handle
- Short style
- Chrome-Vanadium
- Surface chrome-plated

HAZET No.	l ₁ mm	l ₂ mm	EAN-No. 4000896+
428- 6	230	256	019397
428- 7	230	256	019410
428- 8	230	264	019427
428- 9	230	264	019441
428-10	230	264	019281
428-11	230	264	019304
428-12	230	264	019328
428-13	230	264	019335

Hex Nut-Driver

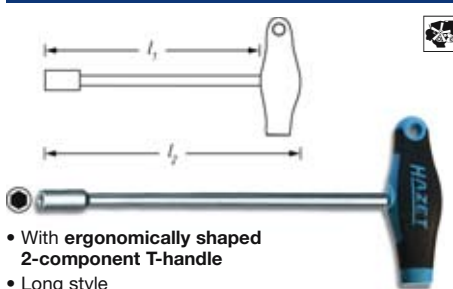

- With ergonomically shaped 2-component T-handle
- Long style
- Chrome-Vanadium
- Surface chrome-plated

HAZET No.	l ₁ mm	l ₂ mm	EAN-No. 4000896+
428 Lg- 8	350	384	019601
428 Lg-10	350	384	019526
428 Lg-12	350	384	019540
428 Lg-13	350	384	019557

6-Point Tubular Box Wrench



- Bright heads
- Solid 6-point shank
- Chrome-Vanadium
- Forged from the solid
- Surface chrome-plated

HAZET No.	l mm	d ₁ mm	d ₂ mm	EAN-No. 4000896+
430- 6 x 7	115	9,5	10,5	019786
430- 8 x 9	120	11,8	13,0	019793
430-10 x 11	130	14,4	16,0	019649
430-12 x 13	140	17,0	18,4	019656
430-14 x 15	150	19,5	20,8	019663
430-16 x 17	160	21,8	23,0	019670
430-17 x 19	170	23,0	26,0	019687
430-18 x 19	170	24,4	26,0	019694
430-21 x 22	180	28,5	30,0	060375
430-24 x 27	190	32,2	36,0	019748
430-30 x 32	200	39,5	41,5	019779

Pin Handle



- For 6-Point Tubular Box Wrenches
- Graduated
- Chrome-Vanadium
- Surface chrome-plated

HAZET No.	l mm	S mm	EAN-No. 4000896+
433-0619	250	6-19	019830
433-2032	280	20-32	019847

Tubular Box Wrench Set (6-Point)



Cardboard packed, 8 pieces

Contents:

430-6 x 7 8 x 9 10 x 11 12 x 13
14 x 15 16 x 17 18 x 19 21 x 22

HAZET No.	EAN-No. 4000896+
430/8	019823



435 x 215 ø62 mm

- 12 pieces
- In sturdy sheet metal case, blue
- With plastic insert

Contents:

430-6 x 7 8 x 9 10 x 11 12 x 13 14 x 15
16 x 17 18 x 19 21 x 22 24 x 27 30 x 32
433-0619 2032

HAZET No.	EAN-No. 4000896+
430-1	019632

Offset Socket Wrench (6-Point)

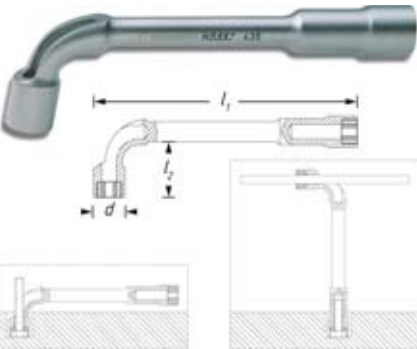

- Suitable for pin handles
- Both ends with 6-point
- With hole in the short offset end
- Solid
- Chrome-Vanadium
- Surface chrome-plated

HAZET No.	l ₁ mm	l ₂ mm	d mm	EAN-No. 4000896+
435-6	95	17	10	076703
435-7	100	19	11	076796
435-8	110	24	12	076802
435-9	115	25	13	076819
435-10	125	27	14,5	076826
435-11	130	29	16,5	076833
435-12	145	31	17,5	076840
435-13	160	34	19	076857
435-14	175	36	20,5	076864
435-15	180	38	21,5	076871
435-16	190	43	23	076888
435-17	195	44	24,5	076895
435-18	200	45	25,5	076901
435-19	210	48	27	076918
435-20	220	50	28	076925
435-21	229	51	29,5	076932
435-22	239	53	31	076949

Offset Socket Wrench (6-Point)

HAZET No.	l ₁ mm	l ₂ mm	d mm	EAN-No. 4000896+
435-23	245	58	32,5	076956
435-24	255	60	33,5	076963
435-25	260	58	35	076970
435-26	265	58	36,5	076987
435-27	275	63	37	076994
435-28	285	63	39	077007
435-29	295	63	40	077014
435-30	305	75	41	077021
435-32	330	75	44	077038

Offset Socket Wrench Set (6-Point)



HAZET No.	EAN-No. 4000896+
435/11	079551
435/11 PL	079797

Plastic drawer insert, empty for 435/11

Double Open-End Wrench



- For areas with restricted access
- Heads set at 15° and 75° (same sizes)
- Short, thin style
- Chrome-Vanadium
- Surface chrome-plated

HAZET No.	l mm	a mm	b mm	EAN-No. 4000896+
440-3,2	70	2	10,5	020119
440-3,5	70	2	10,5	020126
440-4	70	2	10,5	020133
440-4,5	70	2	10,5	020140
440-5	78	2	12,6	020157
440-5,5	78	2	12,6	020164
440-6	78	2	12,6	020171
440-7	91	2	14,7	020188
440-8	96	3	16,8	020195
440-9	103	3	18,9	020201
440-10	105	3	21,0	020065
440-11	116	3	24,2	020072
440-12	116	3	24,2	020089
440-13	131	3	28,3	020096
440-14	131	3	28,3	020102

Double Open-End Wrench Set



- 15 pieces
- In plastic roll

Contents:

440-3,2 3,5 4 4,5 5 5,5 6 7
8 9 10 11 12 13 14

HAZET No.	EAN-No. 4000896+
440/15 P	020232

Double Open-End Wrench



- For powerful use
- Slim heads
- Shank with sturdy double-T-profile
- Chrome-Vanadium
- Surface chrome-plated
- DIN 3110, ISO 10102

HAZET No.	mm	a ₁ a ₂ mm	EAN-No. 4000896+
450 N-4 x 5	99,5	3,2	020683
450 N-5 x 5,5	99,6	3,6	020706
450 N-6 x 7	121,3	3,5	020713
450 N-8 x 9	139	3,8	020744
450 N-8 x 10	140,1	4,1	020737
450 N-10 x 11	155,7	4,6	020355
450 N-10 x 13	172	5,1	020362
450 N-12 x 13	172,7	5,1	020386
450 N-13 x 17	205,5	6,0	020423
450 N-14 x 15	187,8	5,7	020430
450 N-16 x 17	205,7	6,0	020454
450 N-16 x 18	205,7	6,0	020461
450 N-17 x 19	220,9	6,7	020478
450 N-18 x 19	221,2	6,7	020485
450 N-20 x 22	238,9	7,0	020515
450 N-21 x 22	238	7,0	020522
450 N-21 x 23	246	7,1	020539
450 N-22 x 24	254,6	7,1	020553
450 N-24 x 26	269,4	7,8	020560
450 N-24 x 27	269	7,8	020577
450 N-25 x 28	284,2	8,4	020584
450 N-27 x 32	303,8	9,1	020607
450 N-30 x 32	303,4	9,0	020614
450 N-32 x 36	343,2	10,1	020638
450 N-34 x 36	343,2	10,1	020645
450 N-36 x 41	396,7	10,5	020652
450 N-41 x 46	439,5	11,4	020669
450 N-46 x 50	498	12,3	020676

Double Open-End Wrench Set



cardboard packed
450 N/8 in plastic drawer insert

HAZET No.	EAN-No. 4000896+
8 pieces	
Contents:	
450 N-6 x 7 8 x 9 10 x 11 12 x 13 14 x 15 16 x 17 18 x 19 21 x 22	
450 N/8	020850

Double Open-End Wrench Set

HAZET No.	EAN-No.
4000896+	
9 pieces	
Contents:	
450 N-6 x 7 8 x 9 10 x 11 12 x 13 14 x 15 17 x 19 21 x 22 24 x 27 30 x 32	
450 N/9	020874
10 pieces	
Contents:	
450 N-6 x 7 8 x 9 10 x 11 12 x 13 14 x 15 16 x 17 18 x 19 21 x 22 24 x 26 27 x 32	
450 N/10	020751
12 pieces	
Contents:	
450 N-6 x 7 8 x 9 10 x 11 12 x 13 14 x 15 16 x 17 18 x 19 20 x 22 21 x 23 24 x 26 25 x 28 27 x 32	
450 N/12	020775



- In stable plastic clips
- Suitable for wall fixation
- Set of 12 pieces with practical carrying handle

HAZET No.	EAN-No.
4000896+	
8 pieces	
Contents:	
450 N-6 x 7 8 x 9 10 x 11 12 x 13 14 x 15 16 x 17 18 x 19 21 x 22	
450 N/8 RS	020867
12 pieces	
Contents:	
450 N-6 x 7 8 x 9 10 x 11 12 x 13 14 x 15 16 x 17 18 x 19 20 x 22 21 x 23 24 x 26 25 x 28 27 x 32	
450 N/12 RS	020812
12 pieces	
Contents:	
450 N-6 x 7 8 x 9 10 x 11 12 x 13 14 x 15 16 x 17 18 x 19 20 x 22 21 x 23 24 x 27 25 x 28 30 x 32	
450 N/12 N RS	020805



Clip, empty for 450 N/8 RS and 610 N/8 RS

450 N/8 RS L 020294

Clip, empty for 450 N/12 RS, 450 N/12 N RS, 610 N/12 RS

450 N/12 RS L 020270

Double Open-End Wrench



- American sizes
- Chrome-Vanadium
- Surface chrome-plated
- High polished heads

HAZET No.	l mm	a mm	EAN-No.
4000896+			
450 N A- 1/4 x 5/16 VKH	129,9	3,0	020911
450 N A- 5/16 x 3/8 VKH	140,1	4,1	020973
450 N A- 3/8 x 7/16 VKH	155,7	4,6	020966
450 N A- 1/2 x 9/16 VKH	172,4	5,1	020904
450 N A- 5/8 x 5/8 VKH	189,8	5,7	021000
450 N A- 19/32 x 11/16 VKH	205,7	6,0	020935
450 N A- 5/8 x 3/4 VKH	220,9	6,7	020980
450 N A- 25/32 x 7/8 VKH	238,9	7,0	020959
450 N A- 7/8 x 15/16 VKH	254,6	7,1	020997
450 N A- 15/16 x 1 VKH	269,4	7,8	020928
450 N A- 1 x 1 1/8 VKH	284,2	8,4	020942
450 N A- 1 1/16 x 1 1/4 VKH	303,8	9,0	020881
450 N A- 1 1/8 x 1 1/2 VKH	343,2	10,1	020898

Double Open-End Wrench Set



cardboard packed

HAZET No.	EAN-No.
4000896+	
8 pieces	
Contents:	
450 N A- 1/4 x 5/16 5/16 x 3/8 3/8 x 7/16 1/2 x 9/16 19/32 x 11/16 5/8 x 3/4 25/32 x 7/8 15/16 x 1	
450 N A/8 VKH	021031
12 pieces	
Contents:	
450 N A- 1/4 x 5/16 5/16 x 3/8 3/8 x 7/16 1/2 x 9/16 9/16 x 5/8 19/32 x 11/16 5/8 x 3/4 25/32 x 7/8 7/8 x 15/16 15/16 x 1 1 x 1 1/8 1 1/16 x 1 1/4	
450 N A/12 VKH	021017

Open-End Wrench – Striking Face Pattern



- For excessive impact stress
- Special steel
- DIN 133

HAZET No.	l mm	a mm	b mm	EAN-No.
4000896+				
452-27	180	16,0	56	021420
452-30	190	17,0	62	021437
452-32	190	17,0	62	021444
452-36	215	17,5	76	021451
452-41	235	18,5	86	021468

Open-End Wrench – Striking Face Pattern

HAZET No.	l mm	a mm	b mm	EAN-No.
4000896+				
452-46	255	20,0	98	021475
452-50	275	21,0	105	021482
452-55	300	23,0	116	021499
452-60	320	24,5	128	021505
452-65	342	27,0	138	021512
452-70	375	30,0	154	021529
452-75	375	30,0	154	021536
452-80	408	34,0	174	021543
452-85	408	34,0	174	021550
452-90	445	38,0	194	021567
452-95	445	38,0	194	021574
452-100	485	44,0	215	021376

Combination Wrench

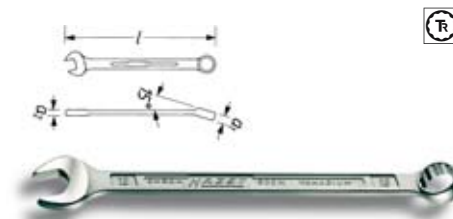

- With Traction profile
- Slim, polished heads
- Shank with stable double-T profile
- Box end 15° offset
- Chrome-Vanadium
- Surface chrome-plated
- DIN 3113, form A, ISO 3318, ISO 7738

* = not according to DIN

HAZET No.	l mm	a ₁ mm	a ₂ mm	EAN-No.
4000896+				
600 N- 5,5*	105	6,0	4,0	023288
600 N- 6	105	6,0	4,0	023295
600 N- 7	118,5	6,6	4,0	023301
600 N- 8	130	7,0	4,5	023318
600 N- 9	143	8,0	4,5	023325
600 N-10	154,5	8,0	5,0	0233028
600 N-11	168,5	8,4	5,5	023035
600 N-12	180,5	9,0	5,5	023042
600 N-13	193	10,0	6,3	023059
600 N-14	204,5	10,0	6,5	023073
600 N-15	218	11,0	7,0	023080
600 N-16	230,5	11,4	7,0	023097
600 N-17	242,5	12,4	7,5	023103
600 N-18	255	13,0	8,0	023110
600 N-19	268,5	13,5	8,0	023127
600 N-20*	279,5	13,5	8,5	023134
600 N-21	292	13,7	8,5	023141
600 N-22	304,5	14,0	8,5	023158
600 N-23*	328	14,3	9,5	023165
600 N-24	328	14,7	9,5	023172
600 N-25*	354	15,0	10,0	023189
600 N-26*	354	15,5	10,0	023196
600 N-27	380	16,0	10,5	023202
600 N-28*	380	16,5	11,0	023219
600 N-29*	380	17,0	11,5	023226
600 N-30	405,5	17,5	12,2	023233
600 N-32	420	18,0	12,0	023240
600 N-34	432	19,0	13,0	023257
600 N-36	460	20,0	13,0	023264
600 N-41	500	20,6	14,0	023271
• Box end 10° offset				
• DIN 3113 form B, ISO 3318, ISO 7738				
600 N-46	520	24,0	15,0	048564
600 N-50	560	26,0	16,5	048571
600 N-55	610	28,0	18,0	048588
600 N-60	660	31,0	20,0	048595
600 N-65*	710	33,0	22,0	048601
600 N-70*	760	35,0	24,0	048618
600 N-75*	810	38,0	26,0	048625
600 N-80*	860	41,0	28,0	048632

Combination Wrench Set

Contents:

603-6 7 8 9 10 11 12 13
14 15 16 17 18 19 21 22 24

HAZET No.	EAN-No. 4000896+
603/17 H	024049



Clips, empty, for 603/17 H

603/17 HL	024056
-----------	--------

Ratcheting Combination Wrench



- Box-end side with reversible ratchet
- Fine tooth, 72 teeth, **turning angle 5°**
- Box-end side 13° offset
- Chrome-Vanadium
- Surface mat chrome-plated
Heads polished

HAZET No.	l mm	a ₁ mm	a ₂ mm	EAN-No. 4000896+
606- 8	129,9	6,8	4,9	100941
606- 9	143	7,2	5,2	100958
606-10	154,5	7,6	5,6	100965
606-11	168,6	8	6	100972
606-12	180,3	8,5	6,4	100989
606-13	193,2	8,9	6,7	100996
606-14	204,6	9,3	7,1	101009
606-15	218	9,7	7,4	101016
606-16	230,2	10,2	7,7	101023
606-17	242,2	10,6	8,1	101030
606-18	255	11	8,5	101047
606-19	268,3	11,5	9,1	101054

Ratcheting Combination Wrench Set



HAZET No.	EAN-No. 4000896+
606/6	115907

6 pieces

Contents:

606-8 10 12 13 17 19

606/6	115907
-------	--------

Plastic drawer insert, empty for 606/6

606/6 PL	115914
----------	--------

Ratcheting Combination Wrench Set



HAZET No.	EAN-No. 4000896+
606/12	118038

12 pieces

Contents:

606-8 9 10 11 12 13 14 15 16 17 18 19

606/12	118038
--------	--------

Plastic drawer insert, empty for 606/12

606/12 PL	118045
-----------	--------

TORX® Double Box-End Wrench



- For outside TORX® screws
- Straight pattern
- Chrome-Vanadium
- Surface chrome-plated, heads polished

HAZET No.	l mm	a ₁ mm	a ₂ mm	EAN-No. 4000896+
609-E 6 x E 8	113	4,8	5,8	024711
609-E 10 x E 12	140	6,8	8,0	024650
609-E 14 x E 18	180	7,9	9,5	024674
609-E 20 x E 24	224	11,0	13,0	024698

Double Box-End Wrench

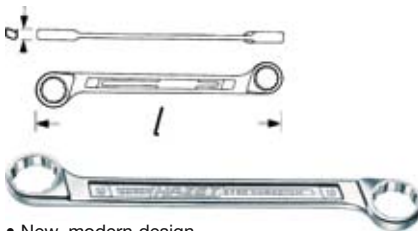

- New, modern design
- Ergonomically shaped, heads offset
- Shank with extra sturdy double-T profile
- Chrome-Vanadium
- Surface chrome-plated heads polished
- DIN 837, form B, ISO 10103

HAZET No.	l mm	a mm	EAN-No. 4000896+
610 N- 6 x 7	97,9	4,5	024940
610 N- 8 x 9	113,3	5,2	024957
610 N-10 x 11	125,3	6,0	024735
610 N-12 x 13	139,0	6,2	024742
610 N-14 x 15	154,5	7,0	024780
610 N-16 x 17	170,0	7,5	024797
610 N-16 x 18	177,2	8,5	024803
610 N-17 x 19	185,0	8,5	024810
610 N-18 x 19	188,6	8,5	024827
610 N-20 x 22	208,8	9,0	024834
610 N-21 x 22	232,3	10,0	024841
610 N-21 x 23	232,3	10,0	024858
610 N-22 x 24	234,5	10,5	024865
610 N-24 x 26	254,0	11,0	024872
610 N-24 x 27	267,1	11,0	024889
610 N-25 x 28	280,1	11,5	024896
610 N-27 x 32	308,7	13,0	024902

Double Box-End Wrench

HAZET No.	l mm	a mm	EAN-No. 4000896+
610 N-30 x 32	324,1	13,0	024919
610 N-30 x 34	326,7	14,0	024926
610 N-36 x 41	393,5	14,9	024933

Double Box-End Wrench Set



cardboard packed

HAZET No.	EAN-No. 4000896+
610 N/8	024995

8 pieces

Contents:

610 N- 6 x 7 8 x 9 10 x 11 12 x 13
14 x 15 16 x 17 18 x 19 21 x 22

610 N/8	024995
---------	--------

10 pieces

Contents:

610 N- 6 x 7 8 x 9 10 x 11 12 x 13 14 x 15
16 x 17 18 x 19 21 x 22 24 x 27 30 x 32

610 N/10-1	024964
------------	--------

12 pieces

Contents:

610 N- 6 x 7 8 x 9 10 x 11 12 x 13 14 x 15
16 x 17 18 x 19 20 x 22 21 x 23 24 x 26
25 x 28 27 x 32

610 N/12	024971
----------	--------



610 N/8 RS

610 N/12 RS

- In sturdy plastic clips
- Suitable for wall fixation
- Set of 12 pieces in clips with handle

HAZET No.	EAN-No. 4000896+
610 N/8 RS	025008

8 pieces

Contents:

610 N- 6 x 7 8 x 9 10 x 11 12 x 13
14 x 15 16 x 17 18 x 19 21 x 22

610 N/8 RS	025008
------------	--------

12 pieces

Contents:

610 N- 6 x 7 8 x 9 10 x 11 12 x 13
14 x 15 16 x 17 18 x 19 20 x 22
21 x 23 24 x 26 25 x 28 27 x 32

610 N/12 RS	024988
-------------	--------



Clip, empty for 450 N/8 RS and 610 N/8 RS

450 N/8 RS L	020294
--------------	--------

Clip, empty for 450 N/12 RS, 450 N/12 N RS, 610 N/12 RS

450 N/12 RS L	020270
---------------	--------

Flare Nut Wrench



- For tube connections, union nuts and male fittings for pipes
- Heads bent 15°
- 6-point end slotted at 30°, 12-point end at 15°
- Chrome-Vanadium
- Surface chrome-plated
- DIN 3118

Note: Wrenches for working on brake lines see HAZET 612 N

+ = with hexagon opening

HAZET No.	l mm	a ₁ mm	a ₂ mm	EAN-No. 4000896+
612- 8 x 10 +	140	7,0	8,0	025206
612-10 x 11 +	147	8,0	8,7	025091
612-11 x 13 +	160	8,7	9,8	025107
612-12 x 14 +	168	9,2	10,3	025114
612-13 x 15	182	9,8	10,9	025121
612-16 x 18	208	12,0	13,2	025145
612-17 x 19	208	12,0	13,2	025152
612-19 x 22	222	13,8	15,8	025169
612-24 x 27	260	16,2	18,0	025183
612-30 x 32	300	21,0	23,0	025190

Brake Line Flare Nut Wrench



- For **screwed connections on brake lines at the front and rear axle**
- Straight design for the operation of the brake line screwing at the front axle
- Offset design for the safe operation of the brake line screwing at the rear axle
- Anti-slipping
- Reinforced design
- Straight slot / with 6-point
- Chrome-Vanadium
- Surface chrome-plated

HAZET No.	l mm	a ₁ mm	a ₂ mm	EAN-No. 4000896+
612 N-10	180	11	11	129027
612 N-11	180	11	11	129133

Flare Nut Wrench



Flare Nut Wrench

- For **screwed connections on brake lines**
- Reinforced design
- Offset
- With 6-point
- Straight slot
- Chrome-Vanadium
- Surface chrome-plated

HAZET No.	l mm	a ₁ mm	a ₂ mm	EAN-No. 4000896+
612 N-8 x 9	157	10,0	10,0	025459
612 N-10 x 11	168	11,0	11,0	025428
612 N-11 x 13	184	11,5	11,5	025435
612 N-12 x 14	197	11,5	11,5	025442

Flare Nut Wrench Set

HAZET No.	EAN-No. 4000896+
Cardboard packed, 4 pieces:	
Contents:	
612 N-8 x 9	10 x 11
612 N/4	11 x 13
	12 x 14
	063925

Ratcheting Open Box-End Wrench



- For the operation of screwed connections in confined spaces
- The **ratchet** allows quick working
- Open 12-point box-end wrench
- Flat style
- For hydraulic, pneumatic and other screwed connections, e.g. for brake lines and high-pressure lines
- Surface chrome-plated, heads burnished
- s 8 12 13 14 17 blister-packed

HAZET No.	l mm	EAN-No. 4000896+
613- 8	137	062508
613-10	137	062515
613-11	137	062522
613-12	137	062539
613-13	137	062546
613-14	184	062553
613-17	184	082551

Ratcheting Open Box-End Wrench Set



Ratcheting Open Box-End Wrench Set

HAZET No.	EAN-No. 4000896+
613/6	071388
Plastic drawer insert, empty for 613/6	
613/6 PL	071333

Double Box-End Wrench



(Starter and Block Wrench)

- Bent style
- Chrome-Vanadium
- Surface chrome-plated, heads polished

HAZET No.	l mm	EAN-No. 4000896+
615-11 x 13	145	025602
615-12 x 14	185	025619
615-13 x 15	185	025626
615-14 x 17	185	025640
615-16 x 18	185	060382
615-17 x 19	235	050901
615-19 x 22	235	025664

Ratcheting Box-End Wrench



- With Traction profile
- Flat style
- Turn wrench to change operation direction from left to right and vice versa
- Special steel
- Surface bright chrome-plated

HAZET No.	l mm	EAN-No. 4000896+
620- 6 x 7	110	025732
620- 8 x 9	140	025749
620-10 x 11	175	025671
620-12 x 13	175	025688
620-14 x 15	205	025695
620-16 x 18	205	025701
620-17 x 19	205	025718
620-21 x 22	235	025725

Ratcheting Box-End Wrench Set

HAZET No.	EAN-No. 4000896+
cardboard packed, 8 pieces	
Contents:	
620-6 x 7	8 x 9
620-8 x 9	10 x 11
620-10 x 11	12 x 13
620-12 x 13	14 x 15
620-14 x 15	16 x 18
620-16 x 18	17 x 19
620-17 x 19	21 x 22
620/8	056224

Ratcheting Box-End Wrench



- With Traction profile
- Reversible for operating to the right and to the left
- 25° offset
- Special steel
- Surface bright chrome-plated

HAZET No.	l mm	EAN-No. 4000896+
621- 6 x 7	110	025817
621- 8 x 9	140	025824
621-10 x 11	170	025756
621-12 x 13	170	025763

Ratcheting Box-End Wrench

HAZET No.	l mm	EAN-No. 4000896+
621-14 x 15	200	025770
621-16 x 18	200	025787
621-17 x 19	200	025794
621-21 x 22	230	025800

Ratcheting Box-End Wrench Set

HAZET No.	EAN-No. 4000896+
Cardboard-packed, 8 pieces	
Contents:	
621-6 x 7	8 x 9
10 x 11	12 x 13
14 x 15	16 x 18
17 x 19	21 x 22
621/8	056217

Double Box-End Wrench



- Low double offset (10°)
- Heads thin-walled
- Chrome-Vanadium
- Surface chrome-plated, heads polished
- ISO 10104

* = not according to DIN

HAZET No.	l mm	a ₁ mm	a ₂ mm	EAN-No. 4000896+
625- 6 x 7*	129,5	7,0	7,0	025978
625- 8 x 9*	149,4	7,5	7,5	025985
625-10 x 11	174,5	8,5	8,5	025848
625-12 x 13	199,5	9,5	9,5	025855
625-14 x 15	209,3	10,0	10,0	025862
625-16 x 18*	244,5	12,0	12,0	025893
625-17 x 19	279,4	12,5	12,5	025909
625-21 x 22*	329,0	14,0	14,0	025923



- American sizes
- Especially long style
- Low double offset
- Heads thin-walled
- Chrome-Vanadium
- Surface chrome-plated

HAZET No.	l mm	a ₁ mm	a ₂ mm	EAN-No. 4000896+
625 A Lg- 1/4 x 5/16	210	5,9	6,9	088171
625 A Lg- 3/8 x 7/16	255	8,0	8,4	088195
625 A Lg- 1/2 x 9/16	291	8,9	9,3	088201
625 A Lg- 5/8 x 3/4	337	11,0	11,2	088218
625 A Lg- 11/16 x 3/4	391	11,9	12,3	088225

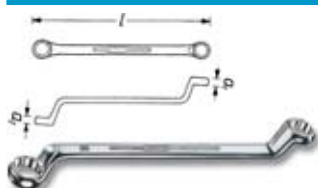

- Deep offset
- Heads thin-walled
- Chrome-Vanadium
- Surface chrome-plated, heads polished
- DIN 838, ISO 10104

Double Box-End Wrench

+ = mat chrome-plated

HAZET No.	l mm	a ₁ mm	a ₂ mm	EAN-No. 4000896+
630- 6 x 7	165	6,0	6,5	026555
630- 8 x 9	180	7,0	7,5	026579
630- 8 x 10	180	7,0	8,0	026562
630-10 x 11	200	8,0	9,0	026227
630-12 x 13	220	9,0	9,5	026241
630-13 x 15	230	9,5	10,5	026265
630-14 x 15	240	10,0	10,5	026296
630-16 x 17	255	11,0	11,3	026302
630-16 x 18	260	11,0	11,6	026319
630-17 x 19	265	11,3	11,9	026326
630-18 x 19	275	11,6	11,9	026333
630-20 x 22	295	12,2	12,9	026364
630-21 x 22	295	12,9	12,9	026371
630-21 x 23	315	12,5	13,2	026388
630-22 x 24	315	12,9	13,5	026395
630-24 x 26	330	13,5	14,1	026401
630-24 x 27	340	13,5	14,4	026418
630-25 x 28	350	13,8	14,7	026432
630-27 x 32	365	14,4	16,0	026463
630-30 x 32	365	15,4	16,0	026470
630-30 x 34	400	15,4	17,0	026487
630-32 x 36	400	16,0	17,2	026494
630-36 x 41 +	440	17,2	18,8	026517
630-41 x 46 +	485	18,8	20,3	026524
630-46 x 50 +	515	20,3	21,6	026531

Double Box-End Wrench Set



Cardboard packed

HAZET No.	EAN-No. 4000896+
8 pieces	
Contents:	
630-6 x 7	8 x 9
10 x 11	12 x 13
14 x 15	16 x 17
18 x 19	21 x 22
630/8	026654
9 pieces	
Contents:	
630-6 x 7	8 x 9
10 x 11	12 x 13
14 x 15	17 x 19
21 x 22	24 x 27
30 x 32	
630/9	026661
10 pieces	
Contents:	
630-6 x 7	8 x 9
10 x 11	12 x 13
14 x 15	16 x 17
18 x 19	21 x 22
24 x 27	30 x 32
630/10-1	026586
12 pieces	
Contents:	
630-6 x 7	8 x 9
10 x 11	12 x 13
14 x 15	16 x 17
18 x 19	20 x 22
21 x 23	24 x 26
25 x 28	27 x 32
630/12	026593

Double Box-End Wrench

- American sizes
- Chrome-Vanadium
- Surface chrome-plated, heads polished
- ISO 1085

HAZET No.	l mm	a ₁ mm	a ₂ mm	EAN-No. 4000896+
630 A- 1/4 x 5/16	170	6,6	7,0	026722
630 A- 3/8 x 7/16	200	8,0	9,0	026807
630 A- 1/2 x 9/16	230	9,5	10,5	026715
630 A- 5/8 x 11/16	255	10,8	11,5	026753
630 A- 3/4 x 3/4	265	11,0	11,9	026821
630 A- 7/8 x 7/8	295	11,9	12,9	026791
630 A- 25/32 x 13/16	295	12,2	12,5	026777
630 A- 15/16 x 1	315	12,5	13,2	026739
630 A- 15/16 x 1	330	13,5	14,1	026746
630 A- 1 x 1 1/8	350	14,1	15,6	026760
630 A- 1 1/16 x 1 1/8	350	14,4	15,0	026708
630 A- 1 1/16 x 1 1/4	365	14,8	16,4	026692

Double Box-End Wrench Set

American sizes, cardboard packed

HAZET No.	EAN-No. 4000896+
8 pieces	
Contents:	
630 A- 1/4 x 5/16	3/8 x 7/16
1/2 x 9/16	5/8 x 11/16
3/4 x 25/32	13/16 x 7/8
15/16 x 1	1 1/16 x 1 1/4
630 A/8	026876
12 pieces	
Contents:	
630 A- 1/4 x 5/16	3/8 x 7/16
1/2 x 9/16	19/32 x 11/16
5/8 x 11/16	5/8 x 3/4
3/4 x 7/8	25/32 x 19/16
7/8 x 15/16	15/16 x 1
1 x 1 1/8	1 1/16 x 1 1/4
630 A/12	026845

TORX® Double Box-End Wrench



- For outside TORX® screws
- Deep offset
- Chrome-Vanadium
- Surface chrome-plated, heads polished

HAZET No.	mm	EAN-No. 4000896+
630-E 4 x E 5	3,86 x 4,75	053513
630-E 6 x E 7	5,74 x 6,22	053520
630-E 8 x E 10	7,52 x 9,42	053537
630-E 11 x E 12	10,08 x 11,17	053544
630-E 14 x E 16	12,90 x 14,76	053551
630-E 18 x E 20	16,70 x 18,49	053568
630-E 22 x E 24	20,31 x 22,16	053575

TORX® Double Box-End Wrench Set

HAZET No.	EAN-No. 4000896+
Cardboard packed, 7 pieces	
Contents:	
630-E 4 x E 5	E 6 x E 7
E 8 x E 10	E 11 x E 12
E 14 x E 16	E 18 x E 20
E 22 x E 24	
630-E/7	056385



Heavy Duty Box-End Wrench



- For excessive use
- Heavy style
- Offset
- Chrome-Vanadium
- Surface chrome-plated

Tubular handles see 640-2430 to -6080

HAZET No.	l ₁ mm	l ₂ mm	a mm	EAN-No. 4000896+
640-24	198,5	559	17,0	027194
640-27	200	560	17,0	027217
640-30	207	568	18,0	027224
640-32	235	721	18,0	027231
640-36	245	731	20,0	027255
640-41	250	736	21,0	027262
640-46	280	912	23,0	027279
640-50	290	922	25,5	027309
640-55	300	925	28,0	027316
640-60	345	1039	30,5	027323
640-65	355	1049	33,0	027347
640-70	365	1059	35,5	027354
640-75	375	1069	38,0	027361
640-80	385	1075	40,5	027378
640-85	385	1076	40,5	027385
640-90	410	1100	45,0	027392
640-95	410	1100	45,0	027408
640-100	412	1103	45,0	027187

Tubular Handle



- Steel tube
- For heavy-duty box-end wrenches
- Surface chrome-plated

HAZET No.	l mm	EAN-No. 4000896+
For wrenches 24 up to 30 mm		
640-2430	460	027200
For wrenches 32 up to 41 mm		
640-3241	610	027248
For wrenches 46 up to 55 mm		
640-4655	760	027286
For wrenches 60 up to 100 mm		
640-6080	860	027330

Box-End Wrench – Striking Face Pattern

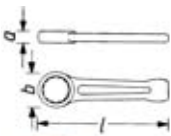

- For excessive impact stress
- Special steel
- DIN 7444

American sizes on request

HAZET No.	l mm	a mm	b mm	EAN-No. 4000896+
642-27	180	16	46	027743
642-30	190	17	52	027750
642-32	190	17	52	027767
642-36	205	18	58	027774

Box-End Wrench – Striking Face Pattern

HAZET No.	l mm	a mm	b mm	EAN-No. 4000896+
642-41	230	20	66	027781
642-46	240	22	74	027798
642-50	255	24	80	027804
642-55	270	25	86	027811
642-60	280	26	93	027828
642-65	300	30	102	027835
642-70	330	33	110	027842
642-75	330	33	110	027859
642-80	360	36	126	027866
642-85	360	36	126	027873
642-90	390	40	142	027880
642-95	390	40	142	027897
642-100	420	45	155	027699

Flexible Head Wrench



- For working in areas with restricted access
- Flexible 12-point socket on both sides
- Chrome-Vanadium
- Surface chrome-plated, heads polished

HAZET No.	l mm	d ₁ mm	d ₂ mm	EAN-No. 4000896+
645- 6 x 7	162,7	9,5	10,5	028283
645- 8 x 9	179,4	12,0	13,5	028290
645-10 x 11	198,5	14,5	16,0	028030
645-12 x 13	214,4	17,5	19,0	028061
645-14 x 15	232,0	20,0	21,5	028092
645-16 x 17	243,2	23,0	24,0	028122
645-17 x 19	259,1	24,0	27,0	028146
645-18 x 19	259,1	25,0	27,0	028160
645-21 x 22	277,0	29,0	30,0	028214

Flexible Head Wrench Set

Cardboard packed

HAZET No.	EAN-No. 4000896+
7 pieces	
Contents:	
645- 8 x 9	10 x 11 12 x 13 14 x 15
16 x 17	18 x 19 21 x 22
645/7	028313

Chassis / Wheels

Tire Iron



- Double-T profile ensures high stability
- Chrome-Vanadium
- Surface chrome-plated

HAZET No.	l mm	EAN-No. 4000896+
For motorcycles		
650- 8	199	028672
For passenger cars and vans		
650-12	303	028627
650-16	396	028634
650-20	500	028641
650-24	598	028658

Tire Iron

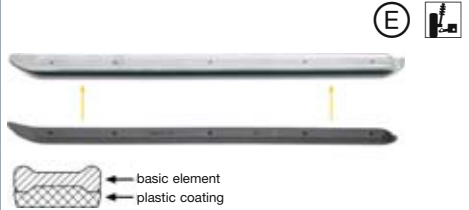

- For installing and removing tires
- For steel and aluminium rims
- With replaceable **plastic coating** fixed by screws
- Chrome-Vanadium
- Surface chrome-plated

HAZET No.	l mm	EAN-No. 4000896+
650 K-20	500	028696



- For commercial vehicles, agricultural and building machinery
- Heavy design
- Chrome-Vanadium

HAZET No.	l mm	EAN-No. 4000896+
652	600	028702



- Especially for tubeless tires
- Heavy design
- Chrome-Vanadium

HAZET No.	l mm	EAN-No. 4000896+
653	456	028719

Balance Weight Pliers



- For installing, removing and cutting **balance weights**
- Also for expanding and compressing the retaining springs
- Chrome-Vanadium
- Surface chrome-plated

HAZET No.	l mm	EAN-No. 4000896+
665	245	029204



- For installing, removing and cutting **balance weights**
- Also suitable for expanding and compressing retaining springs
- **With plastic head** at the hammer side
- Especially for lacquered weights
- Chrome-Vanadium
- Surface chrome-plated

HAZET No.	l mm	EAN-No. 4000896+
665-1	245	029228
Plastic Hammer Head for 665-1		
665-01	-	029211

Balance Weight Pliers



(E)

- For cutting-off large balance weights
- Length of cutting edge 30 mm
- Removal of all balance weights without re-applying the pliers
- For installing and removing balance weights
- Chrome-Vanadium
- Surface chrome-plated

HAZET No.	l mm	EAN-No. 4000896+
665-2	245	127948

Valve Tool



- For installing and removing tire valve cores
- For pushing in the valve pin when deflating the tire, e.g. on passenger cars, transporters and commercial vehicles

HAZET No.	EAN-No. 4000896+
666-1	087136

Valve Retracting Tool



- For pulling rubber-covered valves of different sizes into the rim holes of tubeless tires
- Easy application
- T-handle allows installing the valve without lifting it over the rim edge

HAZET No.	EAN-No. 4000896+
666-2	088461

Valve Tool



For installing and removing the valve inserts on aircraft landing gears

HAZET No.	EAN-No. 4000896+
666-3	136346

Tire Tread Depth Gauge



- Glare-free reading
- Measuring depth 30 mm
- Graduation in 0.1 mm steps for an exact determination of the tread depth
- Light weight and easy handling
- Very robust – made of hard brass
- In practical storage case

HAZET No.	EAN-No. 4000896+
666-5	129164

Pliers for Wheel Nut Caps



- Enables the damage-free removal of wheel nut caps on aluminium rims, e.g. on AUDI, VW and OPEL
- The pliers' jaw tips are especially shaped for the nut caps
- Special steel
- Surface bright chrome-plated, handles with dip coating

HAZET No.	l mm	EAN-No. 4000896+
666-10	160	110575

Removing Tool for Stick-on Weights



- For removing stick-on weights and adhesives from the rims
- For light alloy wheels
- With sharp-edged groove, with screwed-on plastic wedge (for removal of adhesives from the disc wheel)
- Chrome-Vanadium
- Surface mirror galvanized

HAZET No.	l mm	EAN-No. 4000896+
667	155	029235

Tool Set for Tire Pressure Control Systems



- For the appropriate installation of Beru and Schrader tire pressure sensors and the corresponding special tire valves
- These sensors are already used by many vehicle manufacturers on various vehicle types, e.g. BMW (7-series, Z 8), MERCEDES-BENZ (classes CL, E, S, SL), OPEL (Vectra) as well as various passenger cars PEUGEOT, CITROËN, RENAULT, AUDI, VW, PORSCHE
- Set of 6 pieces in plastic box with PUR foam insert

Contents:

666-1
850 Lg-11 12
8502-T20
866 U
6108-1 CT

HAZET No.	EAN-No. 4000896+
669-1	089208

Four-Way Rim Wrench



- For passenger cars, transporters and people carriers
- 705 V-02 additionally equipped with \blacksquare 12.5 = 1/2" for sockets of the 900 series
- Special steel
- Surface chrome-plated, 705: surface powder coated, black
- DIN 3119, ISO 6788

+ = powder coated, black

HAZET No.	mm	EAN-No. 4000896+
705 N	17 x 19 x 13/16 x 21	029389
705 +	17 x 19 x 13/16 x 21	029358
705 V-02	17 x 19 x 22 x 12.5 1/2	029396



- For commercial vehicles, people carriers and campers
- Special steel
- Surface powder coated, black
- DIN 3119, ISO 6788

HAZET No.	mm	EAN-No. 4000896+
710	19 x 22 x 24 x 27	029440



- For passenger cars, transporters and agricultural machinery
- **High capacity**
- **Tested up to 500 Nm**
- Forged central piece
- 715-01 with \blacksquare 12.5 = 1/2" for sockets of the 900 series
- Chrome-Vanadium
- Surface chrome-plated, heads polished
- DIN 3119, ISO 6788

HAZET No.	mm	EAN-No. 4000896+
715	17 x 19 x 13/16 x 22	029457
715-01	17 x 19 x 22 x 12.5 1/2	029464

Four-Way Rim Wrench



- For commercial vehicles, tractors, agricultural and building machinery
- **High capacity**
- **Tested up to 2000 Nm**
- Forged central piece
- 720 S with \blacksquare 20 = 3/4" for sockets of the 1000 series
- Chrome-Vanadium
- Surface chrome-plated, heads polished
- DIN 3119

HAZET No.	mm	EAN-No. 4000896+
720	27 x 30 x 32 x 36 (1.1/16 x 1.3/16 x 1.1/4 x 1.7/16)	029501
720-30	24 x 27 x 30 x 32 (15/16 x 1.1/16 x 1.3/16 x 1.1/4)	029518
720 S	24 x 27 x 32 x 20 3/4	029532

Flat Chisel



- Rectangular stock
- Chrome-Vanadium, air-hardened
- DIN 6453

HAZET No.	mm	mm	EAN-No. 4000896+
730-2	15	125	029563
730-3	18	150	029570
730-4	21	150	029587
730-5	21	175	029594
730-6	24	200	029600
730-7	25	250	029617
730-8	26	300	029624

Hand Guard



Hand guard

HAZET No.	EAN-No. 4000896+
730 HS	029631

Flat Chisel



- Octagonal stock
- Chrome-Vanadium, air-hardened

HAZET No.	mm	mm	EAN-No. 4000896+
731-2	11	125	029648
731-5	15	150	029655

Cape Chisel



- Rectangular stock
- Chrome-Vanadium, air-hardened
- DIN 6451

HAZET No.	mm	mm	EAN-No. 4000896+
740-3	6	150	029679



- Octagonal stock
- Chrome-Vanadium, air-hardened

HAZET No.	mm	mm	EAN-No. 4000896+
741-1	4	125	029709

Drift Punch



- Light design (B)
- Octagonal stock
- Chrome-Vanadium, air-hardened
- Surface mat black
- DIN 6458

HAZET No.	mm	mm	EAN-No. 4000896+
745-1	1	120	029716
745-2	2	120	029723
745-3	3	120	029730

Heavy design (D)

HAZET No.	mm	mm	EAN-No. 4000896+
745 a- 2	2	120	029778
745 a- 3	3	120	029785
745 a- 4	4	120	029792
745 a- 5	5	120	029808
745 a- 6	6	120	029815
745 a- 7	7	120	029822
745 a- 8	8	120	029839
745 a-10	10	150	029761

Center Punch



- Octagonal stock
- Chrome-Vanadium, air-hardened
- DIN 7250

HAZET No.	mm	mm	EAN-No. 4000896+
746-1	120	10	029846
746-2	120	12	029853

Auto-Impact Center Punch



- Impact force 3–30 kg
- Progressively adjustable
- Tough-hard punch tip
- The impact forces will be released by pressing down the upper part
- Special steel

HAZET No.	EAN-No. 4000896+
747-1	051434
Punch tip for 747-1	
747-02	051380

Drift Pin



- Octagonal stock
- Chrome-Vanadium, air-hardened
- DIN 6450, form C

+ = long style

HAZET No.	Ø max. mm	l mm	EAN-No. 4000896+
748 a- 2	2	115	029884
748 a- 3	3	125	029891
748 b- 2	2	150	029907
748 b- 3	3	150	029914
748 b- 4	4	150	029921
748 b- 5	5	150	029938
748 b- 6	6	150	029945
748 b- 8	8	150	029952
748 c- 6 +	6	180	029976
748 c- 8 +	8	200	029983
748 c-10 +	10	200	029969



Chrome-Vanadium, air-hardened

HAZET No.	Ø mm	l mm	EAN-No. 4000896+
• Especially for safety bolts on rear disc brakes MERCEDES-BENZ E-Class 211			
• Ø 3 mm			
748 Lg b-3	10	175	100040
• Especially for safety bolts on disc brakes			
• Ø 4 mm			
748 Lg b-4	10	175	029990



- For safety bolts of **brake linings** on floating caliper brakes, especially OPEL
- With guide pin
- Ø 3 and 5.8 mm
- Chrome-Vanadium
- Surface mat chrome-plated
- DIN 6450

HAZET No.	d ₁ mm	d ₂ mm	l mm	EAN-No. 4000896+
748 Lg b-6	3	5,8	175	030002

Chisels, Drift Punches, Center Punches



Set with 6 pieces in plastic display stand

HAZET No.	EAN-No. 4000896+
Contents:	
731-2 5 741-1 745 a-4 745-3 746-1	
750/6	030026
Contents:	
730-3 6 740-3 745 a-4 745-2 746-2	
750/6-1	030033

Drift Pin Set



Set with 6 pieces in plastic display stand

HAZET No.	EAN-No. 4000896+
Contents:	
748 a-2 3 748 b-4 5 748 c-6 8	
751/6	030088
Contents:	
748 b-2 3 4 5 6 8	
751/6-1	030095

Special Body and Fender Grip Pliers

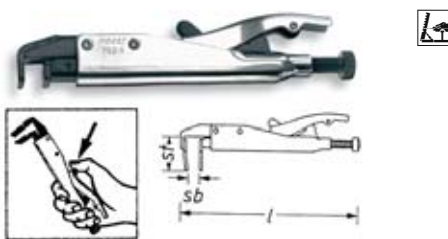

- Cramping to the fold at right angles
- Passenger cars: adjusting of doors, tailgates, engine hoods without removing the pliers
- Especially suitable for curves due to the slim design
- Gripping power works in axial direction
- With quick-release lever
- For application on door entry widths, rear parts, wheel housings, problematical areas, etc.
- Jaws made of special steel
- Bright nickel-plated

HAZET No.	l mm	sb st b mm	EAN-No. 4000896+
752-1	195	18 - 18	030101



- For working on U-beams and weld seams in the fold
- For rear parts (adjustment), rear side panels, U-shaped body profiles, etc.

HAZET No.	l mm	sb st b mm	EAN-No. 4000896+
752-2	205	15-7-18	030125



- For spot welding with shielding gas between the jaws
- Also appropriate for U-beams
- Application on door sills, wheel arches, side panels, problematical areas, etc.

HAZET No.	l mm	sb st b mm	EAN-No. 4000896+
752-3	210	15-9-40	030149

Special Body and Fender Grip Pliers



- For working on rear and side parts, cramping bodywork profiles etc.
- Wide span

HAZET No.	l mm	sb st b mm	EAN-No. 4000896+
752-4	230	15-27-40	030156



- For spot welding within pipe grips
- Application on door entry widths, side parts, folded sheet metal, etc.

HAZET No.	l mm	sb st b mm	EAN-No. 4000896+
752-5	195	15-36-57	030163

Micro-Grip Pliers



- For areas with restricted space
- Only 92 mm long
- Ergonomic design, 120 g light
- Smooth rounded edges
- Straight motion of the mobile jaw
- One hand operation possible
- Brass screw for micrometer adjustment
- High-quality, heat treated aluminium alloy

HAZET No.	l mm	EAN-No. 4000896+
752-10	92	071920

Universal Grip Pliers



- For small round parts and bulky work pieces
- Parallel grip jaws – clamping function –
- One-sided prismatic groove
- Long guide pin
- Quick-release lever
- Jaws made of Chrome-Vanadium
- Surface nickel-plated

HAZET No.	l mm	sb mm	sb mm	EAN-No. 4000896+
753-2	260	200	5-75	030231

Set of Top Jaws



HAZET
No. 4000896+ EAN-No. 4000896+

Top jaws (2 pairs)
for 753-1 and -2

753-01 030187

Grip Pliers



- Straight jaws
- Quick-release lever
- Surface nickel-plated

HAZET
No. 4000896+ EAN-No. 4000896+

753-10 250 35 35 030200



- One jaw straight, one half-round, with one swivel jaw
- Surface nickel-plated

HAZET
No. 4000896+ EAN-No. 4000896+

753-10 S 250 43 16-43 030217

Parallel Grip Pliers



- Straight jaws
- Surface nickel-plated

HAZET
No. 4000896+ EAN-No. 4000896+

754-10 250 50 51 030248

Automatic Grip Pliers



- One-handed use and automatic adjustment
- Variable adjustment of jaw pressure
- New patented locking system
- Easy and safe release – the jaws will be kept in locked position unless the release lever is pressed
- The cam mechanism allows to adjust the pliers automatically to any size applying a constant jaw pressure
- Anti-slip surface

HAZET
No. 4000896+ EAN-No. 4000896+

755- 6 A 161 0-32 126569

755- 7 A 192 0-44 126576

755-10 A 230 0-44 126590

Universal Grip Pliers



- Jaws half-round
- Quick-release lever
- Surface nickel-plated

HAZET
No. 4000896+ EAN-No. 4000896+

757- 5 142 25 0-25 062300

757- 7 178 20 8-30 030347

757-10 230 50 6-50 030293

757-12 300 30 10-65 030323

Grip Welding Clamp



- Especially for getting over obstacles
- Quick-release lever
- Surface nickel-plated

HAZET
No. 4000896+ EAN-No. 4000896+

758-1 280 51 35-60 030361

Grip Pliers



- For bulky objects
- Quick-release lever
- Surface nickel-plated

HAZET
No. 4000896+ EAN-No. 4000896+

758-2 275 90 170 75 030378



- Especially large clamping depth
- Quick-release lever
- Surface nickel-plated

HAZET
No. 4000896+ EAN-No. 4000896+

758-3 460 240 75-100 260 030385

758-4 600 320 75-100 400 030392

Universal Pliers



- Water pump pliers
- Box-joint
- Jaw and joint polished
- Surface lacquered red
- DIN ISO 8976

HAZET
No. 4000896+ EAN-No. 4000896+

759 N-2 250 30 6-35 030415



- Lay-on slip joint
- Surface chrome-plated
- DIN ISO 8976

HAZET
No. 4000896+ EAN-No. 4000896+

760-1 120 20 6-26 030422



Source: MAN

Universal Pliers



- **High capacity**
- Fluted lay-on slip joint
- **Relief-milled** guide flutes
- Induction hardened
- Chrome-Vanadium
- Surface chrome-plated, bright heads
- DIN ISO 8976

HAZET No.	l mm	sb mm	sb mm	EAN-No. 4000896+
760 N-1	180	30	45	030460
760 N-2	260	50	65	030484
760 N-3	310	65	80	030514
760 N-4	415	110	120	030538

Rim Wrench



- For commercial vehicles
- Chrome-Vanadium
- Surface chrome-plated, bright heads

HAZET No.	mm	mm	l mm	EAN-No. 4000896+
769-1	24 x 27	1 5/16 x 1 1/16	402	030743
769-2	28 x 33	- x 1 5/16	402	030750
769-30	30 x 32	3/16 x 1 1/4	402	030767
769 S-3	32 x 38	1/2 x 1 1/2	407	030781

Handle Bar



For above mentioned Rim Wrenches 769 chrome-plated

HAZET No.	l mm	Ø mm	EAN-No. 4000896+
769-4	630	19	030774

Rim Wrench



- Telescoping
- Special steel
- Surface chrome-plated

HAZET No.	l mm	mm	EAN-No. 4000896+
771-17	364-520	17	030798
771-19	380-535	19 3/4	030828
771-21	380-535	21	030859

Rim Wrench



303 - 535 mm

Rim Wrench

- Solid telescopic part, drop forged
- With \blacksquare square drive 12.5 = 1/2"
- For sockets of the series HAZET 900
- Special steel
- Surface chrome-plated

HAZET No.	l mm	mm	EAN-No. 4000896+
772	303-535	12 1/2	030897

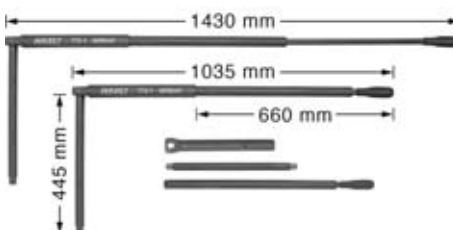

- For installing and removing wheel nuts/bolts on commercial vehicles
- Extra long lever arm (max. length 1,430 mm) allows application of high forces (up to 1,200 Nm in extended position)
- 3 pieces – tool can be disassembled and allows space-saving storage in the storage or tool box
- 8-point extension for deeply located screwed connections
- For the operation of sockets of different sizes figuring in the $\square 3/4$ range, e.g. HAZET 1000 S
- The fitting accuracy of interior and exterior tube provides exact and safe fit in every length
- Safety pin avoids unintentional loosening – removing of safety pin with pin $\varnothing 3$ mm
- Special welding method provides force-fit connection of inside square $\square 3/4$ and exterior tube
- Highly-tempered special steel, burnished

HAZET No.	l mm	mm	EAN-No. 4000896+
772-1	1035-1430	20 3/4	123957

Piston Ring Pliers



- For installing and removing piston rings
- Special steel
- Surface bright nickel-plated

HAZET No.	Ø mm	l mm	EAN-No. 4000896+
790-1	50-100	220	031412
790-1 a	65-110	240	031429
790-2	110-150	280	031443

Piston Ring Pliers



- With prism holder for safe grip of various piston ring types
- Special steel
- Surface nickel-plated, burnished prism holder

HAZET No.	Ø mm	l mm	EAN-No. 4000896+
790-3	60-120	220	031450

Valve Stem Seal Ring Pliers



- For removing valve stem seals on **2-valve engines**
- On VW/AUDI, FORD, OPEL, NISSAN, etc.
- Serrated
- Hardened jaws
- Surface nickel-plated, jaws burnished

HAZET No.	l mm	EAN-No. 4000896+
791-5	250	031467



- For easy and reliable removing of deeply located valve stem seals due to the extra long jaws
- For **multi-valve engines**, e.g. on OPEL, VW and FORD
- Serrated and dip-coated jaws
- Jaws hardened
- Straight
- Surface nickel-plated

HAZET No.	l mm	EAN-No. 4000896+
791-8	270	061068

Valve Spring Compressor



- With 1 pair of straight and bent jaws each,
 - 792-1 with straight jaws sb 75-225
 - with bent jaws sb 45-195
 - 792-2 with straight jaws sb 120-280
 - with bent jaws sb 90-250
- Surface bright nickel-plated

HAZET No.	l mm	EAN-No. 4000896+
792-1	290	031481
792-2	380	031511

Piston Ring Compressor



- With square key for tensioning
- May be locked continuously
- High-strength spring band steel

HAZET No.	Ø mm	h mm	EAN-No. 4000896+
794-01	40 - 75	50	031597
794-1	60 - 125	80	031610
794-2	90 - 175	80	031641
794-3	90 - 175	165	031665

Piston Ring Compressor



- For compression of piston rings on water- and air-cooled engines
- **Tightening strap (width 32 mm), can easily be unlatched**
- Surface chrome-plated

HAZET No.	Ø mm	l mm	EAN-No. 4000896+
794 U-3	70 - 100	302 - 332	031672

Valve Refacer



With suction cup

HAZET No.	Ø mm	EAN-No. 4000896+
795-1	20	031771
795-2	25	031788
795-3	30	031795
795-4	37	031801

Brake Spring Pliers



- For installing and removing the brake shoe recuperating spring on **riveted brake linings**
- Surface chrome-plated

HAZET No.	l mm	EAN-No. 4000896+
796	215	031818

Brake Spring Pliers



- For **glued and riveted brake linings**
- With movable claw
- Surface chrome-plated

HAZET No.	l mm	EAN-No. 4000896+
797	317	031825

Hose Clamp Pliers



- For simple hose clamps, e.g. on washing machines
- Movable jaws
- Surface chrome-plated

HAZET No.	sb mm	l mm	EAN-No. 4000896+
798	40	206	031832



- For simple hose clamps
- With locking device
- Movable jaws
- Surface chrome-plated

HAZET No.	sb mm	l mm	EAN-No. 4000896+
798-1	45	285	031900



- For clamping multi-use **CLIC-type hose clamps** on fuel lines, e.g. on VW-AUDI, OPEL, PEUGEOT and ALFA ROMEO
- Open and close easily by turning the pliers by 180°
- With fixed jaws, bent at 90°

HAZET No.	sb mm	l mm	EAN-No. 4000896+
798-2	20	175	051397

Hose Clamp Pliers



- For clamping multi-use **CLIC-type hose clamps** that are used, e.g. on fuel lines. Application on e.g. AUDI, VW, OPEL, PEUGEOT, SMART and MERCEDES-BENZ
- Open and close easily by turning the pliers by 180°
- **Movable jaws** - for use in areas with restricted access
- Chrome-Vanadium
- Surface nickel-plated

HAZET No.	sb mm	l mm	EAN-No. 4000896+
798-3	35	206	102433



- For spring band hose clamps
- Movable jaws

HAZET No.	sb mm	l mm	EAN-No. 4000896+
798-4	35	205	031948



- For spring band hose clamps, e.g. on VW-AUDI and OPEL
- Movable jaws

HAZET No.	sb mm	l mm	EAN-No. 4000896+
798-5	6-12	210	031955



- For spring band hose clamps **12 and 15 mm wide**, 13 - 22 mm Ø
- Rotating safety jaws

HAZET No.	sb mm	l mm	EAN-No. 4000896+
798-6	40	235	031962

Hose Clamp Tension Device



- For self-gripping **spring band hose clamps** *sb* 8 – 52 mm Ø
- Enables working in areas with restricted access
- 6-point drive *s* 6 mm
- Easy working in conjunction with Reversible Ratchet 863 P, optionally with Flexible Extension 870 or 870-2 and 6-Point Socket 850-6 may also be used with Screwdriver for slotted screws (802 or 803) or Flexible Hex Nut-Driver 426-6
- Surface galvanized

HAZET No.	<i>sb</i> mm	EAN-No. 4000896+
798-7	8–52	083206

Hose Clamp Pliers



- For self-gripping spring band hose clamps
- Self-adjusting joint allows easy working even on large hose clamps with large diameter
- With locking device
- Handles with plastic coating

HAZET No.	<i>sb</i> mm	<i>l</i> mm	EAN-No. 4000896+
798-8	45	290	076697



- Especially for **12 and 15 mm** self-gripping spring band hose clamps
- **Movable jaws**
- **Bent at 110°** – allowing application in areas with restricted access
- With locking device

HAZET No.	<i>sb</i> mm	<i>l</i> mm	EAN-No. 4000896+
798-9	60	250	072163

Hose Clamp Pliers



- For spring band hose clamps
- Adjustable opening width
- Fixed jaws
- With locking device
- Especially for VW-AUDI

HAZET No.	<i>sb</i> mm	<i>l</i> mm	EAN-No. 4000896+
798-10	90	320	031917



- For spring band hose clamps
- Especially for **12 mm and 15 mm** spring band hose clamps, e.g. on OPEL, VW, FORD, RENAULT, FIAT, PEUGEOT, CITROËN, PORSCHE, ALFA-ROMEO, MERCEDES-BENZ, SMART
- With locking device
- Adjustable opening width
- Handles plastic coated

HAZET No.	<i>sb</i> mm	<i>l</i> mm	EAN-No. 4000896+
798-12	80	320	031931



- For the operation of spring band hose clamps whose three ends are located on tubes, e.g. on fuel lines and tank ventilation lines on VW, AUDI, SEAT, SKODA
- Chrome-Vanadium
- Surface nickel-plated

HAZET No.	<i>sb</i> mm	<i>l</i> mm	EAN-No. 4000896+
798-14	8–18	177	109128

HIGHLIGHTS



Hose Clamp Pliers



(E)

- For the operation of self-gripping spring band hose clamps sb 7–60 mm \varnothing
- **Bowden cable** (610 mm) enables application in areas with restricted access where the application of usual hose clamp pliers is not possible
- With **toothed fixing device**
- Newly developed slide device with integrated tension spring and adjustable reversible plate
- Application on cooling and heating circuits
- Handles with plastic coating for better gripping comfort

HAZET No.	sb mm	l mm	EAN-No. 4000896+
798-15 A	7–60	875	097258
Bowden cable for 798-15 A complete with fixing kit, 2 x nuts M 4			
798-0151 A			097753
Bowden cable for 798-15 A and B			
798-0152 A			097760
Slide device for 798-15 A and B			
798-0153 A			097784



(E)

- **New design with plastic coated semiflexible Bowden cable**
- One-hand operation – release of the fixing device by pressing the button on the handle
- Especially appropriate for areas with restricted access where the application of usual pliers is not possible
- The Bowden cable allows working without a guiding hand and is suitable for overhead working as well as for areas located deeply in the motor
- For the operation of self-gripping spring band hose clamps on cooling and heating circuits
- Newly developed slide device with integrated tension spring and adjustable reversible plate
- Automatic toothed fixing device for the fixation of the mounting/dismounting position
- Handles with plastic coating for better gripping comfort

Hose Clamp Pliers

HAZET No.	sb mm	l mm	EAN-No. 4000896+
798-15 B	7–60	875	117727
Flexible hose for 798-15 B			
798-0150 B			142439
Bowden cable for 798-15 A and B			
798-0152 A			097760
Slide device for 798-15 A and B			
798-0153 A			097784

(E)

Door-Spring Pliers



- For installing and removing the stop spring of the window crank
- Surface chrome-plated, jaws burnished

HAZET No.	sb mm	l mm	EAN-No. 4000896+
799	8–45	210	031986

Lever for Removing Door Panels



- For removing **fixing plugs** on door panels
- With protective coating
- Jaw opening 28 mm
- Special steel

HAZET No.	l mm	EAN-No. 4000896+
799-3	268	031993

Pliers for Dismantling Door Panels



- For removing the fixing bolts on **door panels**, mouldings and bumper rubber strips
- Coated for the protection of vehicle lacquer
- Special steel

HAZET No.	l mm	EAN-No. 4000896+
799-4	230	032013

Pliers for Dismantling Door Panels



- For removing the fixing bolts on **door panels**, mouldings and bumper rubber strips
- Coated for the protection of vehicle lacquer
- Among others for VW Sharan, FORD Galaxy and SEAT Alhambra
- Special steel

HAZET No.	l mm	EAN-No. 4000896+
799-5	285	052042

Lever for Removing Door Panels



- For removing the fixing plugs on door panels
 - VW Sharan since 1996, Touareg since 2003, Touran since 2004, Phaeton since 2003
 - SEAT Alhambra since 1996
 - FORD Galaxy since 1995
- Lever provides an optimal power transmission
- Special steel with protective coating
- Ergonomic plastic handle

HAZET No.	l mm	EAN-No. 4000896+
799-6	260	110346

Lever for Removing Tailgate Covers



- Universal tool for removing and installing the difficultly accessible **fixing springs** of inside coverings
- Especially suitable for the tailgate coverings on: **VW** Golf IV, **AUDI** A3, A6, A4 Avant, **SEAT** León as well as on identically constructed vehicles

HAZET No.	l mm	EAN-No. 4000896+
799-7	500	129362